

**PLEASE CHECK WWW.MOLEX.COM FOR LATEST PART INFORMATION**

**Part Number:** [0877590664](#)

**Status:** **Active**

**Overview:** milligrd

**Description:** 2.00mm (.079") Pitch Milli-Grid™ Header, Surface Mount, Vertical, 6 Circuits, 0.38µm (15µ") Gold (Au) Selective Plating, without Press-fit Plastic Pegs, Pick-and-Place Cap, Tube Packaging, Lead-free

**Documents:**

[3D Model](#)

[Product Specification PS-87761-100 \(PDF\)](#)

[Drawing \(PDF\)](#)

[RoHS Certificate of Compliance \(PDF\)](#)

**Agency Certification**

UL E29179

**General**

Product Family	PCB Headers
Series	<a href="#">87759</a>
Application	Board-to-Board
Overview	<a href="#">milligrd</a>
Product Name	Milli-Grid™

**Physical**

Breakaway	Yes
Circuits (Loaded)	6
Circuits (maximum)	6
Color - Resin	Black
Durability (mating cycles max)	100
First Mate / Last Break	No
Flammability	94V-0
Glow-Wire Compliant	No
Guide to Mating Part	No
Keying to Mating Part	None
Lock to Mating Part	None
Mated Height (in)	0.150 In
Mated Height (mm)	3.80 mm
Material - Metal	Phosphor Bronze
Material - Plating Mating	Gold
Material - Plating Termination	Tin
Material - Resin	Nylon
Number of Rows	2
Orientation	Vertical
PCB Locator	No
PCB Retention	None
Packaging Type	Tube
Pitch - Mating Interface (in)	0.079 In
Pitch - Mating Interface (mm)	2.00 mm
Pitch - Term. Interface (in)	0.079 In
Pitch - Term. Interface (mm)	2.00 mm
Plating min: Mating (µin)	15
Plating min: Mating (µm)	0.38
Polarized to Mating Part	No
Polarized to PCB	No
Robotic Placement	Pick and Place Cap
Shrouded	No
Stackable	No
Temperature Range - Operating	-55°C to +105°C

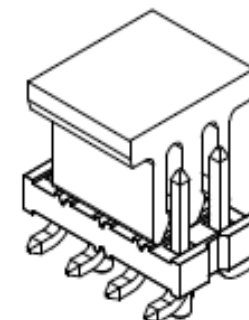

image - Reference only

Series

**EU RoHS**

**ELV and RoHS Compliant**

**REACH SVHC**

Not Reviewed

**Halogen-Free**

**Status**

**Not Reviewed**

**China RoHS**



**Need more information on product environmental compliance?**

Email [productcompliance@molex.com](mailto:productcompliance@molex.com)  
For a multiple part number RoHS Certificate of Compliance, [click here](#)

Please visit the [Contact Us](#) section for any non-product compliance questions.

**Search Parts in this Series**

[87759Series](#)

**Mates With**

[79107](#) Milli-Grid™ Receptacle, Vertical, Through Hole. [79108](#) Milli-Grid™ Flex-to-Board, Vertical Receptacle. Milli-Grid™ Receptacle, Surface Mount. [79109](#). [87381](#)

Termination Interface: Style Surface Mount

### **Electrical**

Current - Maximum per Contact 2A  
Voltage - Maximum 125V

### **Solder Process Data**

Duration at Max. Process Temperature (seconds) 10  
Lead-free Process Capability Reflow Capable (SMT only)  
Max. Cycles at Max. Process Temperature 3  
Process Temperature max. C 260

### **Material Info**

#### **Reference - Drawing Numbers**

Packaging Specification PK-89990-476  
Product Specification PS-87761-100  
Sales Drawing SD-87759-117

This document was generated on 05/25/2010

**PLEASE CHECK [WWW.MOLEX.COM](http://WWW.MOLEX.COM) FOR LATEST PART INFORMATION**

F

E

D

C

B

A

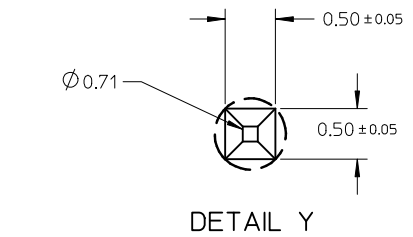
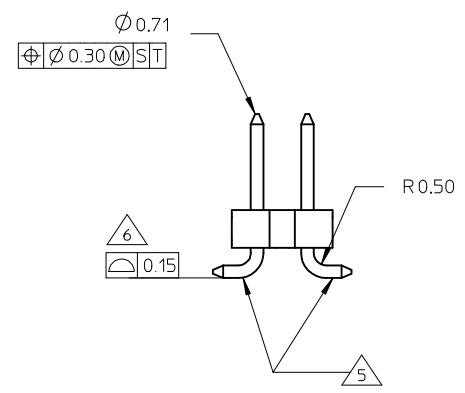
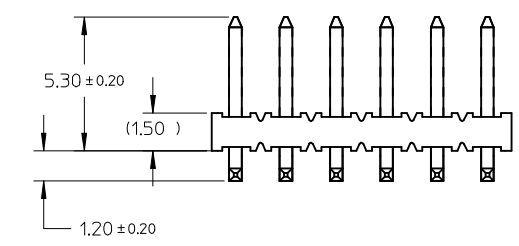
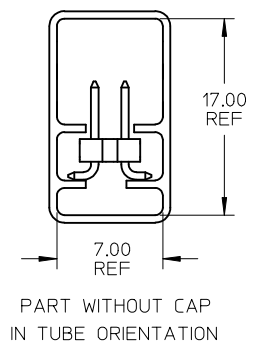
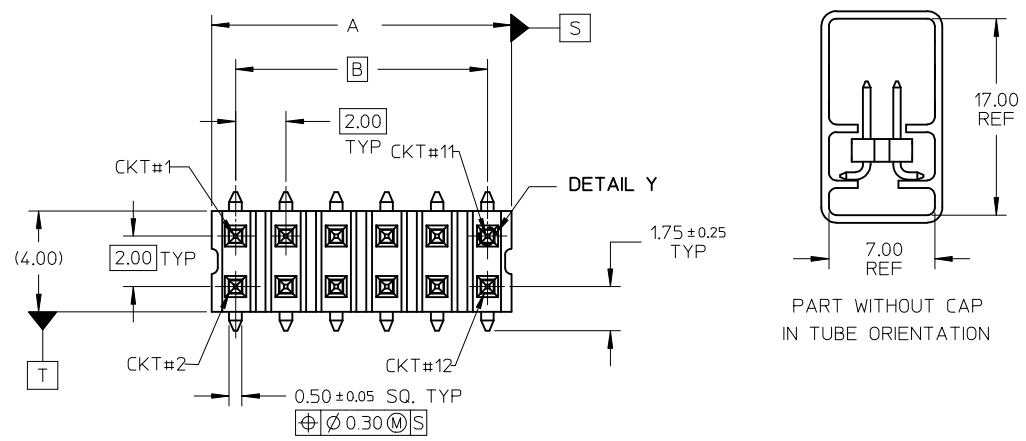

- NOTE:
- MATERIAL:  
HSG & CAP - NYLON, GLASS FILLED  
UL 94V-0, COLOUR BLACK  
  
PIN - 0.50 SQ PHOSPHOR BRONZE
  - PLATING:  
0.38um MIN GOLD PLATE AT CONTACT AREA,  
TIN PLATE AT SOLDER AREA,  
BOTH OVER NICKEL UNDERPLATE
  - PIN PUSHOUT FORCE: 1KG MIN IN EITHER DIRECTION
  - PRODUCT SPEC PS-87761-100 APPLIES.
  - BEND DEPRESSION IS ACCEPTABLE SO LONG AS IT DOES NOT AFFECT THE OVERALL COPLANARITY OF TAIL.
  - COPLANARITY IS TO BE MEASURED BY RESTING THE SOLDER TAIL ON A FLAT SURFACE.
  - CAP TO BE LOCATED AS CENTRAL OF PART AS POSSIBLE  
TOP SURFACE OF CAP TO BE FLAT FOR THE PURPOSE OF PICK & PLACE BY VACUUM SUCTION NOZZLE.
  - FOR ILLUSTRATION PURPOSES, 12CKT IS SHOWN.
  - CKT 4 & 6 IS CUT FROM CKT 8 & 12 RESPECTIVELY  
ROUGH EDGES ARE EXPECTED ALONG THE CUTTING EDGES.
  - PART TO BE PACKED IN TRAY ONLY.
  - TUBE LENGTH IS 560MM REF STANDARD.

ADD. OPTION EC NO: S2009-0510 DRWN:ATSEE 2009/01/23 CHKD:SKANG 2009/02/09 APPR:MLONG 2009/02/17	QUALITY SYMBOLS ▽=0 ◻=0	GENERAL TOLERANCES (UNLESS SPECIFIED)		DIMENSION STYLE MM ONLY	SCALE NTS	DESIGN UNITS METRIC	THIRD ANGLE PROJECTION		
		mm	INCH	DRAWN BY	DATE	TITLE			
		4 PLACES ± ---	± ---	KSEE	2003/12/12	CUSTOM HEADER			
		3 PLACES ± ---	± ---	CHECKED BY	DATE	MGRID, 2MM DUAL ROW HDR. SMT			
2 PLACES ± 0.2	± ---	KCL ING	2004/01/12	APPROVED BY					
1 PLACE ± ---	± ---	SKTOH	2004/01/12	DATE					
ANGULAR ± 3 °		MATERIAL NO.		DOCUMENT NO.		SHEET NO.			
DRAFT WHERE APPLICABLE MUST REMAIN WITHIN DIMENSIONS		SEE TABLE		SD-87759-117		1 OF 6			
B2		SIZE A3		THIS DRAWING CONTAINS INFORMATION THAT IS PROPRIETARY TO MOLEX INCORPORATED AND SHOULD NOT BE USED WITHOUT WRITTEN PERMISSION					

F

E

D

C

B

A

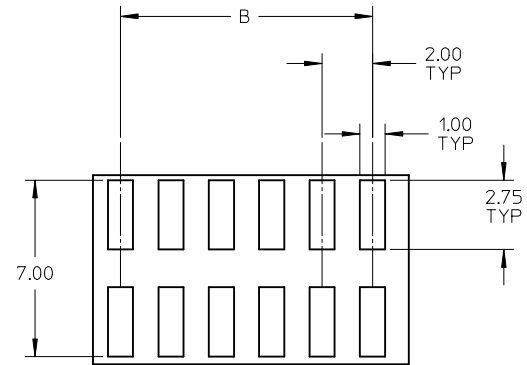
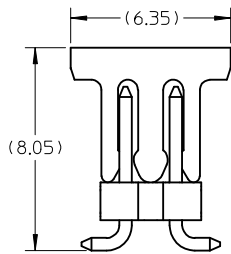
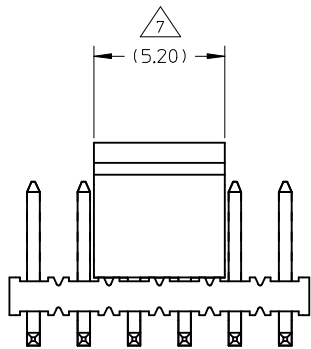

RECOMMENDED SOLDER PAD LAYOUT

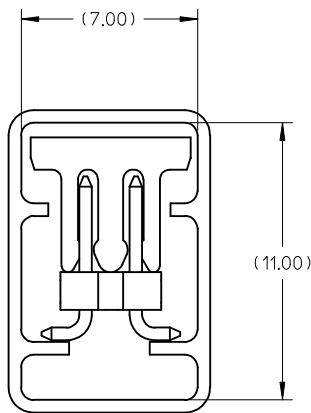

ADD. OPTION EC NO: S2009-0510 DRWN:ATSEE 2009/01/23 CHKD:SKANG 2009/02/09 APPR:MLONG 2009/02/17	QUALITY SYMBOLS ▽=0 ◻=0	GENERAL TOLERANCES (UNLESS SPECIFIED) mm INCH	DIMENSION STYLE MM ONLY	SCALE NTS	DESIGN UNITS METRIC	THIRD ANGLE PROJECTION		
	4 PLACES ± --- ± --- 3 PLACES ± --- ± --- 2 PLACES ± 0.2 ± --- 1 PLACE ± --- ± ---	DRAWN BY DATE KSEE 2003/12/12 CHECKED BY DATE KCLING 2004/01/12 APPROVED BY DATE SKTOH 2004/01/12	TITLE CUSTOM HEADER MGRID, 2MM DUAL ROW HDR. SMT					
	ANGULAR ± 3 °	MATERIAL NO.	MOLEX INCORPORATED					
	DRAFT WHERE APPLICABLE MUST REMAIN WITHIN DIMENSIONS	SEE TABLE	DOCUMENT NO.	SD-87759-117				
B2	REV DESCRIPTION	SIZE A3		THIS DRAWING CONTAINS INFORMATION THAT IS PROPRIETARY TO MOLEX INCORPORATED AND SHOULD NOT BE USED WITHOUT WRITTEN PERMISSION				

EMBOSSED CARRIER TAPE TYPE "A"

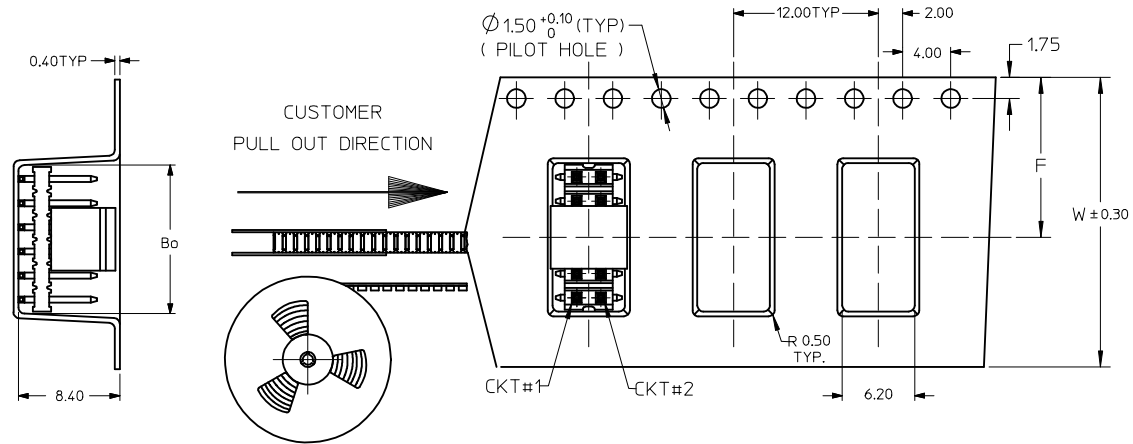

NOTES:

12. LEADER AND TRAILER TAPE



13. PEELING OFF FORCE OF THE TOP TAPE: 20-80gf.  
(PEELING DIRECTION AS SHOWN IN FOLLOWING FIGURE)

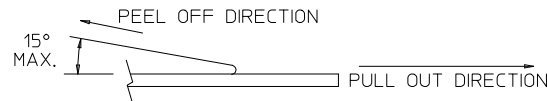

- 14. PACKAGING STANDARD IS AS PER EIA-481.
- 15. TAPE & REEL QUANTITY = 750 PCS/REEL
- 16. THE TAPE IS TREATED FOR ANTI-STATIC

ADD. OPTION EC NO: S2009-0510 DRWN:ATSEE CHKD:SKANG APPR:MLONG	2009/01/23 2009/02/09 2009/02/17	DESCRIPTION REV	QUALITY SYMBOLS	GENERAL TOLERANCES (UNLESS SPECIFIED)	DIMENSION STYLE	SCALE	DESIGN UNITS	THIRD ANGLE PROJECTION
			$\nabla=0$ $\sphericalangle=0$	mm    INCH 4 PLACES ± --- ± --- 3 PLACES ± --- ± --- 2 PLACES ± 0.2 ± --- 1 PLACE ± --- ± --- ANGULAR ± 3 °	MM ONLY	NTS	METRIC	TITLE
				DRAFT WHERE APPLICABLE MUST REMAIN WITHIN DIMENSIONS	DRAWN BY: KSEE    DATE: 2003/12/12 CHECKED BY: KCLING    DATE: 2004/01/12 APPROVED BY: SKTOH    DATE: 2004/01/12	CUSTOM HEADER MGRID, 2MM DUAL ROW HDR. SMT	MOLEX INCORPORATED DOCUMENT NO. SD-87759-117	SHEET NO. 3 OF 6
				SEE TABLE	THIS DRAWING CONTAINS INFORMATION THAT IS PROPRIETARY TO MOLEX INCORPORATED AND SHOULD NOT BE USED WITHOUT WRITTEN PERMISSION			

EMBOSSED CARRIER TAPE TYPE "B"

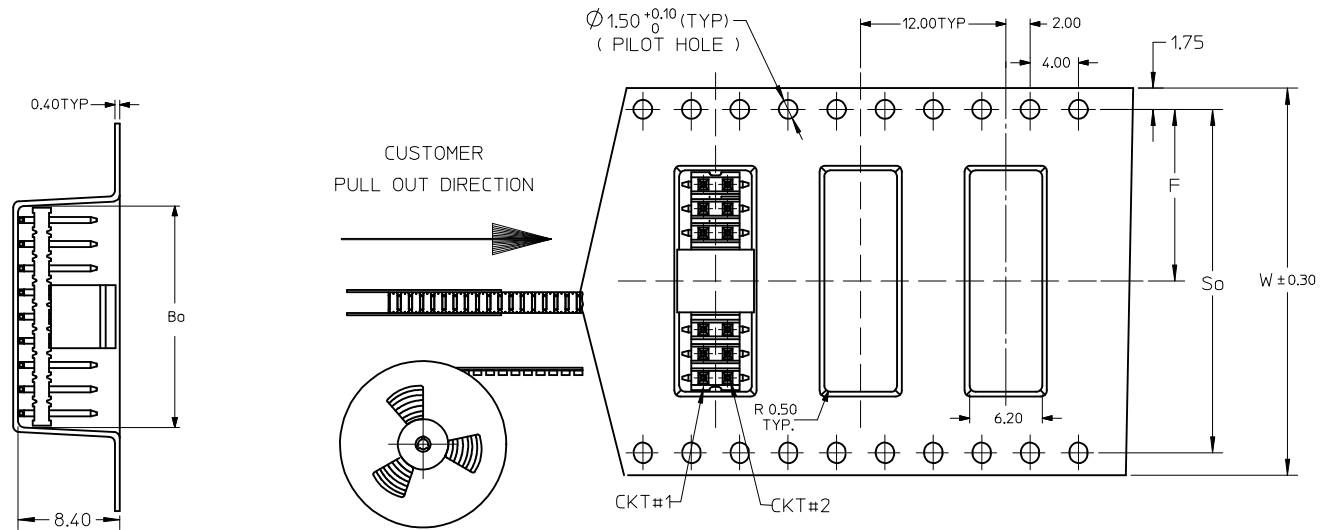

ADD. OPTION EC NO: S2009-0510 DRWN:ATSEE 2009/01/23 CHKD:SKANG 2009/02/09 APPR:MLONG 2009/02/17	QUALITY SYMBOLS ▽=0 ◻=0	GENERAL TOLERANCES (UNLESS SPECIFIED) mm INCH 4 PLACES ± --- ± --- 3 PLACES ± --- ± --- 2 PLACES ± 0.2 ± --- 1 PLACE ± --- ± --- ANGULAR ± 3 °	DIMENSION STYLE MM ONLY DRAWN BY DATE KSEE 2003/12/12 CHECKED BY DATE KCLING 2004/01/12 APPROVED BY DATE SKTOH 2004/01/12	SCALE NTS DESIGN UNITS METRIC THIRD ANGLE PROJECTION	TITLE CUSTOM HEADER MGRID, 2MM DUAL ROW HDR. SMT
	DESCRIPTION B2	DRAFT WHERE APPLICABLE MUST REMAIN WITHIN DIMENSIONS	MATERIAL NO. SEE TABLE	MOLEX INCORPORATED DOCUMENT NO. SD-87759-117	SHEET NO. 4 OF 6
	SIZE A3	THIS DRAWING CONTAINS INFORMATION THAT IS PROPRIETARY TO MOLEX INCORPORATED AND SHOULD NOT BE USED WITHOUT WRITTEN PERMISSION			

THIS TYPE OF CARRIER IS FOR CKT SIZE 8 AND BELOW.



<b>ADD. OPTION</b> EC NO: S2009-0510 DRWN:ATSEE 2009/01/23 CHKD:SKANG 2009/02/09 APPR:MLONG 2009/02/17	DESCRIPTION REV	QUALITY SYMBOLS ▽=0 ◻=0	GENERAL TOLERANCES (UNLESS SPECIFIED)		DIMENSION STYLE <b>MM ONLY</b>		SCALE NTS	DESIGN UNITS METRIC	THIRD ANGLE PROJECTION		
			mm	INCH	DRAWN BY	DATE	TITLE				
		4 PLACES	± ---	± ---	KSEE	2003/12/12	<b>CUSTOM HEADER            MGRID, 2MM DUAL ROW HDR.            SMT</b>				
		3 PLACES	± ---	± ---	CHECKED BY	DATE					
2 PLACES	± 0.2	± ---	KCLING	2004/01/12	<b>MOLEX INCORPORATED</b>						
1 PLACE	± ---	± ---	APPROVED BY	DATE							
			ANGULAR ± 3 °		SKTOH	2004/01/12	DOCUMENT NO.		SHEET NO.		
			DRAFT WHERE APPLICABLE MUST REMAIN WITHIN DIMENSIONS		SEE TABLE		SD-87759-117		5 OF 6		
					SIZE	THIS DRAWING CONTAINS INFORMATION THAT IS PROPRIETARY TO MOLEX INCORPORATED AND SHOULD NOT BE USED WITHOUT WRITTEN PERMISSION					
					A3						

	10	9	8	7	6	5	4	3	2	1		
	PART NUMBER WITHOUT CAP IN TUBE	PART NUMBER WITH CAP IN TUBE	PART NUMBER WITH CAP IN TAPE AND REEL.	CKT SIZE	VOID CKTS	A	B	Bo	F	So	W	EMBOSSED TYPE
F	87759-0414 $\triangle_9 \triangle_{10}$	87759-0464	87759-0474	4	--	NA	2.00	5.40	11.50	-	24.00	C
	87759-0614 $\triangle_9$	87759-0664	87759-0674	6	--	NA	4.00	7.20	11.50	-	24.00	C
	87759-0814	87759-0864	87759-0874	8	--	7.90	6.00	8.20	11.50	-	24.00	C
	87759-1014	87759-1064	87759-1074	10	--	9.90	8.00	10.20	11.50	-	24.00	A
	87759-1002 $\triangle_A$	87759-1003 $\triangle_A$	87759-1004 $\triangle_A$	10	10	9.90	8.00	10.20	11.50	-	24.00	A
	87759-1214	87759-1264	87759-1274	12	--	11.90	10.00	12.20	11.50	-	24.00	A
E	87759-1414	87759-1464	87759-1474	14	--	13.90	12.00	14.20	11.50	-	24.00	A
	87759-1614	87759-1664	87759-1674	16	--	15.90	14.00	16.20	14.20	28.40	32.00	B
	87759-1814	87759-1864	87759-1874	18	--	17.90	16.00	18.20	14.20	28.40	32.00	B
	87759-2014	87759-2064	87759-2074	20	--	19.90	18.00	20.20	14.20	28.40	32.00	B
	87759-2214	87759-2264	87759-2274	22	--	21.90	20.00	22.20	20.20	40.40	44.00	B
D	87759-2414	87759-2464	87759-2474	24	--	23.90	22.00	24.20	20.20	40.40	44.00	B
	87759-2614	87759-2664	87759-2674	26	--	25.90	24.00	26.20	20.20	40.40	44.00	B
	87759-2814	87759-2864	87759-2874	28	--	27.90	26.00	28.20	20.20	40.40	44.00	B
	87759-3014	87759-3064	87759-3074	30	--	29.90	28.00	30.20	20.20	40.40	44.00	B
	87759-3214	87759-3264	87759-3274	32	--	31.90	30.00	32.20	20.20	40.40	44.00	B
	87759-3414	87759-3464	87759-3474	34	--	33.90	32.00	34.20	26.20	52.40	56.00	B
	87759-3614	87759-3664	87759-3674	36	--	35.90	34.00	36.20	26.20	52.40	56.00	B
C	87759-3814	87759-3864	87759-3874	38	--	37.90	36.00	38.20	26.20	52.40	56.00	B
	87759-4014	87759-4064	87759-4074	40	--	39.90	38.00	40.20	26.20	52.40	56.00	B
	87759-4214	87759-4264	87759-4274	42	--	41.90	40.00	42.20	26.20	52.40	56.00	B
	87759-4414	87759-4464	87759-4474	44	--	43.90	42.00	44.20	26.20	52.40	56.00	B
	87759-4614	87759-4664	87759-4674	46	--	45.90	44.00	46.20	26.20	52.40	56.00	B
	87759-4814	87759-4864	87759-4874	48	--	47.90	46.00	48.20	26.20	52.40	56.00	B
B	87759-5014	87759-5064	87759-5074	50	--	49.90	48.00	50.20	34.20	68.40	72.00	B

NOTES:  
 $\triangle_A$  VOIDED PIN CKT#10 FOR PART#87759-1002

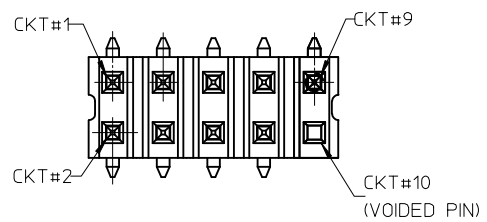

<b>ADD. OPTION</b> EC NO: S2009-0510 DRWN:ATSEE 2009/01/23 CHKD:SKANG 2009/02/09 APPR:MLONG 2009/02/17 <b>B2</b>	<b>QUALITY SYMBOLS</b> $\nabla=0$ $\triangle=0$	<b>GENERAL TOLERANCES (UNLESS SPECIFIED)</b> <table border="1"> <tr> <th></th> <th>mm</th> <th>INCH</th> </tr> <tr> <td>4 PLACES</td> <td><math>\pm</math> ---</td> <td><math>\pm</math> ---</td> </tr> <tr> <td>3 PLACES</td> <td><math>\pm</math> ---</td> <td><math>\pm</math> ---</td> </tr> <tr> <td>2 PLACES</td> <td><math>\pm</math> 0.2</td> <td><math>\pm</math> ---</td> </tr> <tr> <td>1 PLACE</td> <td><math>\pm</math> ---</td> <td><math>\pm</math> ---</td> </tr> </table>		mm	INCH	4 PLACES	$\pm$ ---	$\pm$ ---	3 PLACES	$\pm$ ---	$\pm$ ---	2 PLACES	$\pm$ 0.2	$\pm$ ---	1 PLACE	$\pm$ ---	$\pm$ ---	<b>DIMENSION STYLE</b> <b>MM ONLY</b> DRAWN BY: KSEE DATE: 2003/12/12 CHECKED BY: KCLING DATE: 2004/01/12 APPROVED BY: SKTOH DATE: 2004/01/12 MATERIAL NO.	<b>SCALE</b> NTS <b>DESIGN UNITS</b> METRIC <b>THIRD ANGLE PROJECTION</b>	<b>TITLE</b> CUSTOM HEADER MGRID, 2MM DUAL ROW HDR. SMT <b>MOLEX INCORPORATED</b> DOCUMENT NO. SD-87759-117	SHEET NO. 6 OF 6
				mm	INCH																
			4 PLACES	$\pm$ ---	$\pm$ ---																
			3 PLACES	$\pm$ ---	$\pm$ ---																
2 PLACES	$\pm$ 0.2	$\pm$ ---																			
1 PLACE	$\pm$ ---	$\pm$ ---																			
<b>DRAFT WHERE APPLICABLE MUST REMAIN WITHIN DIMENSIONS</b>	<b>SEE TABLE</b>																				
THIS DRAWING CONTAINS INFORMATION THAT IS PROPRIETARY TO MOLEX INCORPORATED AND SHOULD NOT BE USED WITHOUT WRITTEN PERMISSION																					
<b>SIZE</b> A3																					